

Sierra

Machine Warewash Dosing System

Installation and Operation Manual



SAFETY NOTES

- Make sure Sierra is disconnected from power source before servicing.
- Refer installation and service to qualified personnel only. Installation must comply with all applicable plumbing and electrical codes.
- When removing or installing Sierra pump components, wear adequate protective clothing such as gloves and safety glasses or goggles.

INTRODUCTION

This manual describes how to use the Sierra Machine Warewash Dosing System.

Material in this manual is subject to change without notice. Manual revisions will be made on an as needed basis. Special circumstances involving important design, operation or application information will be released via Equipment Technical Bulletins.

If the equipment is used in a manner not specified by Beta Technology, Inc. or Beta Europe, the protection provided by the equipment may be impaired.

© Beta Technology, Inc., Beta Europe, 2001

OVERVIEW

The Sierra is a two or three-chemical product dispensing system for use with probe or probeless control of conveyor or door-type warewashing machine applications.

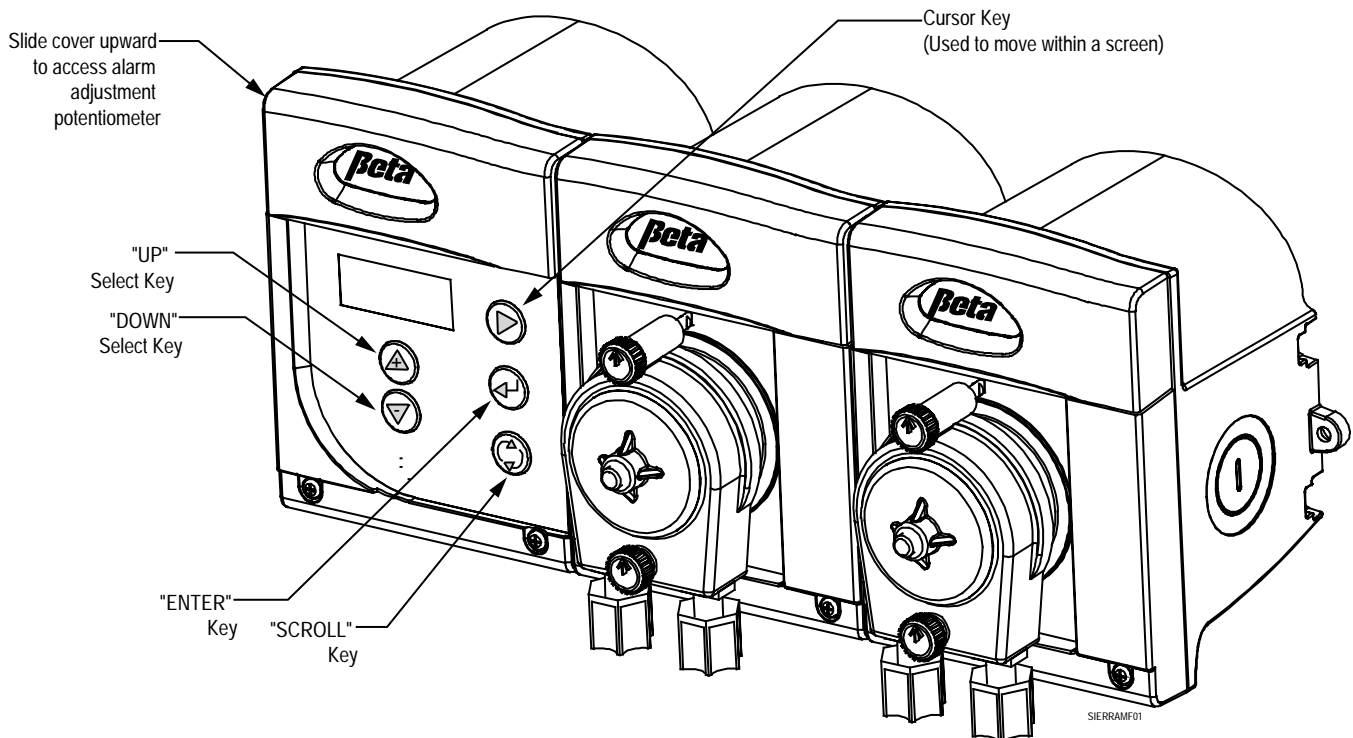

Figure 1. Sierra, Typical Two-Product System

EQUIPMENT INFORMATION

Model	Pump Types/ Solenoid Included				Sanitizer	Code No.
	Liquid Detergent	Detergent Solenoid (plastic)	Detergent Solenoid (brass)	Liquid Rinse		
Three Product	✓			✓	✓	1201193
Three Product			✓	✓	✓	1201189
Three Product		✓		✓	✓	1201191
Two Product			✓	✓		1201183
Two Product		✓		✓		1201185
Two Product	✓			✓		1201187
Single Pump Add-on					✓	1201231

SIERRAMT06

Table 1. Sierra Configurations and Item Numbers



All models come with complete installation kit (includes non-temperature compensating probe) and injector fitting. Contact Customer Service for description of installation kits and other configurations.

General

All programming is done through a 5-button keypad and 2-line, 16-character display.

“Smart” Screens

The “Smart” Screen concept simplifies the configuration process by only displaying the screens that are applicable to your application mode and machine type. For example, if you program your Sierra to run in Probe rather than Time mode, the Sierra will only display subsequent programming and status screens that apply to Probe mode.

Internal Datalogging

The Sierra can store and display vital information such as total racks washed, racks washed since last drain, total drains, wash ON hours, and detergent feed ON hours. Sierra can store up to 999 hours of data.

Priming

The detergent, rinse and sanitizer pumps are each selected using the UP/DOWN keys, primed by pressing the ENTER button when the desired pump name is displayed on the screen. Pumps run at 100% speed when primed.

VCP™ (Virtual Clean Probe)*

Sierra comes with the patented VCP™ technology. VCP guarantees superior probe performance by eliminating the effects of fouling caused by calcium and protein buildup. If you are concerned about probe performance and accuracy, VCP is an

excellent way to reduce the need for service calls, reduce chemical waste, and ensure optimal results.

ENABLE/DISABLE Feature for Warewash Machine Maintenance

Sierra allows the operator to disable chemical dosing with the push of a button, allowing him to perform warewash machine maintenance procedures without dispensing chemicals. When maintenance procedures are complete, dosing may be re-enabled with the push of a button.

Languages

The Sierra can be operated in English, French and Spanish, or in a Numeric system depending on configuration.

PROBE MODE OPERATIONS

Wash Tank Concentration

Setpoint is programmed in Beta Units for accurate and repeatable control. The range is 0 to 70 Beta Units, with a typical operating values ranging from 25 to 55 Beta Units.

Wash Tank Concentration/Temperature

Both can be displayed in real time on the alphanumeric display.

Low Detergent Alarm

A sonic alarm beeps when wash tank concentration fails to reach a level of at least 5 Beta Units below setpoint within the alarm delay time.

Once a low-detergent alarm has occurred, the alarm will not reset until conductivity reaches programmed setpoint or the ENTER key is pressed. The wash ON trigger will not reset the counter.

Best Practice for Reducing Service Calls and Improving Results

To set up the low detergent alarm, empty the tank, do an initial charge (largest charge) and measure the charge time. Add five seconds to this initial charge time, and use this number as your alarm delay time.

Over Feed Stop

When the low detergent alarm is present, the Over Feed Stop timer begins running for the programmed number of seconds (0 to 240). If the conductivity is not at least 5 Beta Units below setpoint at the end of the this interval, the detergent pump will stop, and the alarm will stop beeping and will sound continuously. The operator must press ENTER to cancel alarm and resume detergent feed.

Ratio Feed

The Ratio Feed feature consists of a 10-second period within which you may program a percentage of “on time.” For example, if you program the Ratio Feed to 6, the feed will run for 6 seconds and shut off for 4 seconds This cycle will repeat until the setpoint is reached.

This feature activates when the wash tank concentration comes within 5 Beta Units of the programmed conductivity setpoint, and is used to prevent the feed from overshooting this setpoint. Sierra uses this system instead of reduced detergent speed because it controls both pumps and solenoids.

TIME MODE OPERATIONS

Recharge Dose for Conveyor Machines

This is the amount of time that the detergent pump will run each time one rack’s worth of time (as programmed from Screen 18) has lapsed.

Recharge Dose for Door Machines

Sump type - Detergent recharge dose time (range 0-20 seconds) is delivered each time the rinse cycle power starts.

Fill and dump type - Detergent dose time (range 0-24 seconds) is delivered each time the wash cycle power starts.

Initial Fill Charge for Conveyor Machines

Detergent initial fill charge time (range 0-240 seconds, default is 20 seconds) is delivered when the Sierra senses an initial fill, or an operator closes a remote switch.

Initial Fill Charge for Door Machines

Sump type - Detergent initial fill charge time (5-99 seconds, default is 20 seconds) is delivered when rinse power on-time exceeds 20 seconds.

Fill and dump type - Initial charge time should be set to zero.

Rinse Delay Time (Door Machines Only)

Rinse pump delay time after a rinse cycle start can be programmed (range 0-20 seconds, default is 00 seconds). Rinse pump speed (range 0-100%, default is 20%) and rinse pump run time (range 0-99 seconds, default is 15 seconds) are programmed to deliver the desired amount of product.

Best Practice for Optimum Results

If rinse results are not as good as expected, make the rinse delay time eight seconds shorter than the rinse time. This will ensure that the rinse chemical does not get washed off. Do this prior to increasing the rinse speed or time. Not using rinse delay increases rinse use.

Solenoid Operation

Sierra can power and control a DC solenoid valve. When controlling a solenoid, the speed must be set to 100%.

Sanitizer Operation

Sanitizer pump can run with either the detergent pump (destainer application) or the rinse pump (sanitizer application). Application and pump speed (range 0-100%, default is 30%) are programmed during setup to deliver the correct amount of product.

Pressure Switch

The Sierra can operate with any contact-closure pressure switch. Beta does not currently supply any pressure switches that can be mounted internally. Contact Technical Support to discuss further implementation.

TERMS

Beta Units

A means of indicating the detergent concentration in the wash tank. The probe measures the conductance of the solution. This electrical measurement is converted into and displayed as Beta Units. Each Beta Unit change represents a 5% conductance change. For example, 23 Beta Units is 95% as great as 24 Beta Units, and 105% of 22 Beta Units.

For a graph that further describes Beta Units, see Beta Unit Graph in the **Sierra Training Sheet**.

SPECIFICATIONS

PHYSICAL DIMENSIONS, CONSTRUCTION AND MOUNTING

Three-Product Enclosure

Height	Width	Depth
5.75	15.25	5.5 Inches
14.61	40.96	13.97 Centimeters

Two-Product Enclosure

Height	Width	Depth
5.75	11.50	5.5 Inches
14.61	31.12	13.97 Centimeters

Weight

4.38 lbs (2 kg) maximum for 3-pump system.

Cabinet Material



ABS – Flame Retardant
IP54 Water-Resistant

Mounting

Wall mounted with stainless steel bracket, allowing easy installation in all locations. Use #8 x 1 inch (#8 x 25mm) screws. Do not use plastic feet for mounting Sierra.

OPERATING CONDITIONS

Ambient Operating Temperature

36 to 104° Fahrenheit
(2 to 40° Celsius)

Electrical Power Configurations

100-240VAC, 50-60 Hz, 0.3 Amp (max)

Fuse

Sierra has no user-serviceable fuse.

COMPONENTS

Pumps

Peristaltic, dual roller, self-priming and self-checking.

Tube Materials

Detergent

Norprene (standard), B-Flex, Silicone, Viton, Nordel, C-Flex

Rinse

Biwall (standard) B-Flex, Silicone, Norprene, Nordel, C-Flex

Sanitizer

Norprene (standard), B-Flex, Silicone, Norprene (food grade)

Pump Flow Rates

Pump 1: Detergent 0.188" (4.77 mm) ID tube, adjustable
5% to 100%, (0.24 to 4.8 oz, 7 to 140 ml) per minute

Pump 2: Rinse 0.063" (1.60 mm) ID tube, adjustable
5% to 100%, (0.025 to 0.5 oz, 0.75 to 15 ml) per minute

Pump 3: Sanitizer 0.125" (3.18 mm) ID tube, adjustable
5% to 100%, 0-2 oz (0-60 ml) per minute

Triggers

Wash and Rinse Voltage Range

24VAC to 240VAC
24VDC to 100VDC

Current

0.5 mA minimum (at 24VDC)

Signal Connections

- Wash signal is typically connected across either motor contactor coil or fill solenoid valve, or as specified by dishwasher manufacturer.
- Rinse signal is typically connected across the rinse solenoid valve, or as specified by dishwasher manufacturer.

Hydraulic Performance

Pump 1: Detergent

Maximum Vacuum 8 in (200 mm) of mercury
Maximum Pressure 1.4 bar (20 psi)

Pumps 2 and 3, Rinse and Sanitizer

Maximum Vacuum 8 in (200 mm) of mercury
Maximum Pressure 2.1 bar (30 psi)

Best Practice for Optimum Performance

Optimum rinse performance requires 16-22 psi pressure.

SOLENOID

10 watts, 24VDC

PROBE

Conductivity Range

660 - 12,800 mS, K = 0.4

ALARMS

Sierra has an adjustable, audible alarm. To adjust alarm volume, slide top cover upward on controller unit, and adjust potentiometer using a flat-head screwdriver. To increase volume, turn potentiometer clockwise. Emits 80db at 4 feet (1.22 meters). Alarm acknowledgement will defer display of any new alarms up to five minutes.

Low Level Alarm

Display reads "CHECK PRODUCTS"

Overfeed Stop Alarm (Probe Operation Only)

Display reads "DET FEED FAILURE" (Screen 10b)

Detergent Alarm Timeout

Display reads "ADD DETERGNT" (Screen 10a)

Wash Tank Dump Alarm

Display reads "DUMP TANK" (Screen 19a)

APPROVALS

CSA, NSF, CE approved



To comply with NSF regulations, sight glass must be used with sanitizer pump.

INSTALLATION & SETUP

See **Sierra Training Sheet** for system setup information for specific installations.

PHYSICAL INSTALLATION



Refer installation and service to qualified personnel only. Installation must comply with all applicable plumbing and electrical codes.

Mounting the Unit

Carefully select a place to mount the unit. Remember that there must be room around it for access to switches, buttons, wires and tubing, and to open enclosure for installation and maintenance. Mount the unit against a stable wall with the pumps side-by-side and their tube openings at the bottom. Avoid steam and other sources of moisture, such as from spray or splash. Do not subject the unit to temperatures outside the range 36 °F to 120 °F (2 °C to 49 °C)

Only mount the unit with the mounting bracket. Do not use the end tabs.

Best Practice for Optimum Results

Ensure that all chemicals and equipment are on the dirty side of the cleaning process for regulatory compliance with agencies such as OSHA.

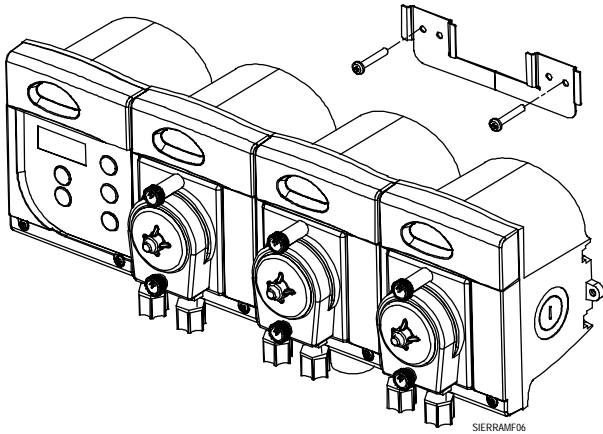

Figure 2. Sierra with Mounting Bracket

Opening the Unit for Servicing

1. To open a Sierra module, slide cover and gently pry off. It may be necessary to use a flathead screwdriver. Take care not to damage the unit.
2. Use a Phillips screwdriver to remove the four screws.
3. Remove face plate.
4. Reverse this process to close the module. Ensure gasket is in place to maintain water resistance.

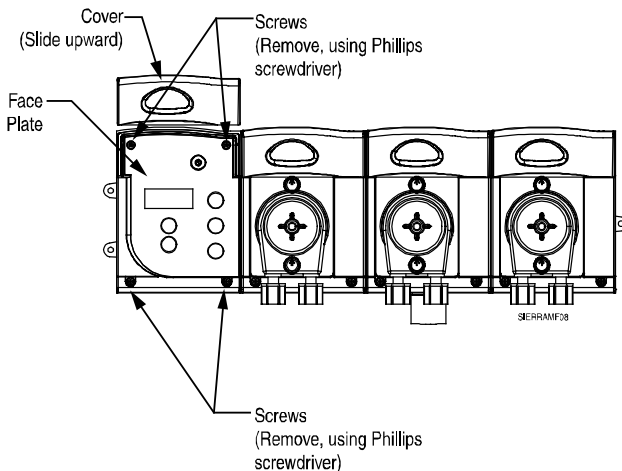

Figure 3. Opening Unit for Servicing

Installing the Conductivity Probe

If suitable for the application, use the washer manufacturer's predrilled access hole. Otherwise, punch a 7/8 inch (2.2 centimeter) hole through the wash tank in a location that will provide accurate sampling of the detergent solution. Typically, you would mount the probe about 4 inches (10 centimeters) above the bottom of the tank, away from any heater elements, corners or any mechanical components (such as water level floats). Smooth the edges so gaskets will seal well, and mount the probe.

Best Practice for Optimum Results

Install probe directly under the carriage line and feed point, but above the water line (taking into account the addition of rinse water after the wash water). Mount the probe with the probe tips vertical, not horizontal as shown:

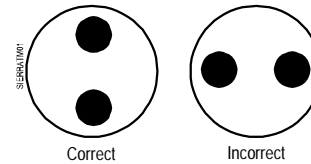

Installing the Detergent Bulkhead Fitting

Punch a 7/8-inch (23 mm) hole in the wash tank in a suitable location below the water level line. For best results, mount the fitting directly above the point where the probe is located. A bulkhead fitting for a typical installation is included in the installation kit supplied with the Sierra, or with the powder/solid detergent hopper.

Connecting the Pressure Switch

A pressure switch can be used to sense demand for rinse (and sanitizer). In these installations, the pressure switch should be connected to the machine rinse line downstream of the rinse solenoid, either directly or through the rinse injector fitting. Use a 1/4 inch line for this purpose.

Connecting Chemical Supply Lines

Delivery Lines		
Pump Type	Inlet	Outlet
Detergent	1/4 inch (6 mm)	1/4 inch (6 mm)
Rinse	1/4 or 1/8 (4 or 6 mm)	1/4 or 1/8 (4 or 6 mm)
Solenoid	1/4 inch (6 mm)	1/4 inch (6 mm)

Table 2. Pump Types/Sizes

To ensure an airtight connection between the chemical inlet tube and the fitting, push the tube all the way into the fitting until it stops. The best way to do this is to:

1. Remove the nut from the fitting.
2. Put the fitting then end of the chemical line and slide the tube through the nut until 1/2" (13 mm) of tube extends through the nut.
3. Push the tube into the appropriate tube end.
4. Push the nut until it meets the fitting.
5. Tighten to a secure fit. See Figure 4.

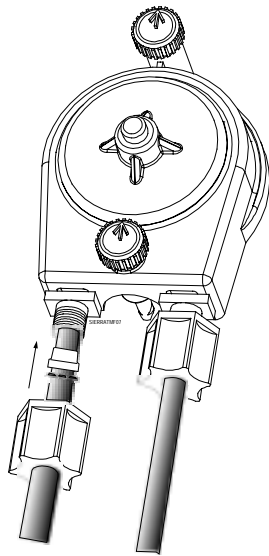

Figure 4. Installing Chemical Tubing



It is very important that the nut components be installed correctly, as shown in Figure 4.

6. Run the lines to the chemical drums, and secure the end of each supply line into its respective container. Use a snap-in standpipe for liquid chemical lines. To ensure that chemical is properly supplied to Sierra, we recommend using a standpipe or other securing device to support and hold the chemical uptake tube in place within the chemical drum. A plastic standpipe is the **Accessories and Spare Parts** section of this manual.
7. Cut the line at a 45° angle.
8. Press the feed end of the line into the open part of the U.
9. Leave the bottom of the standpipe slightly lower than the inlet of the line.

Chemical Output Lines

1. Connect the 1/4 inch line or 1/8-inch line, as appropriate, to the nut on the right (outlet side) of the squeeze tubes. Tighten the nut on the fitting. See Figure 4.
2. Run the feed line to a bulkhead or injector fitting (see **Accessories and Spare Parts** for a complete listing). Use as short a line as possible and keep the lines away from steam pipes, open flues or other areas where machine operators could accidentally damage them.
3. In this and other output line runs, always try to avoid uphill runs.
4. Secure the line into the fitting.



The rinse pump is capable of pumping against 40 psi but it is not advisable to operate at this level. The rinse pump tubing life will be severely shortened. Most dishwasher manufacturers specify no more than 25 psi in the washer rinse line, and the water pressure should always be below this specification to ensure optimum performance and results.

Plumbing Connections to Water Solenoid

- Solenoids are used to supply water to a powder or solid detergent hopper.
- The compression fittings on the solenoid inlet and outlet accept either 1/4 inch plastic line or 1/4 inch copper tube.
- Follow the flow arrows on the solenoid when making connections.
- Consult the instructions supplied with the detergent hopper.
- Regulate water pressure to the hopper in the range from 20 to 30 psi (1.4 to 2.1 bar).

Best Practice for Optimum Results

Use hot water (120-130°F) from the water heater, not from booster heater (150-160°F). Using the hotter wash tank heater water will cause the chemicals to activate too soon and lose their effectiveness.

ELECTRICAL CONNECTIONS



To maintain the safety rating of this equipment, the following requirements must be observed:

- Wire size for Main Power and all high voltage connections must be a minimum of 20 AWG, rated for 600 volts.
- Suitable earth ground must be provided.
- A service disconnect must be provided for either this equipment, or the equipment to which it is attached.
- All knockouts are intended for flexible conduit only.

Sierra Wiring Connectors

Sierra has three wiring connector knockouts on the bottom and one on the side of each controller and pump module.

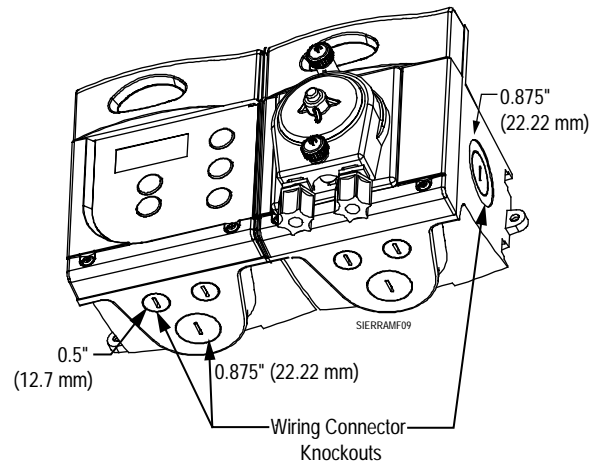

Figure 5. Bottom/Side Knockouts

1. Insert a flat-head screwdriver into the center slot of knockout and gently punch through.
2. Twist and rotate the screwdriver 90 degrees, prying out plastic center of hole.

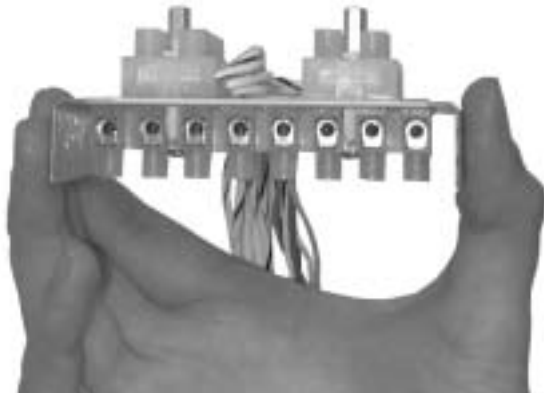
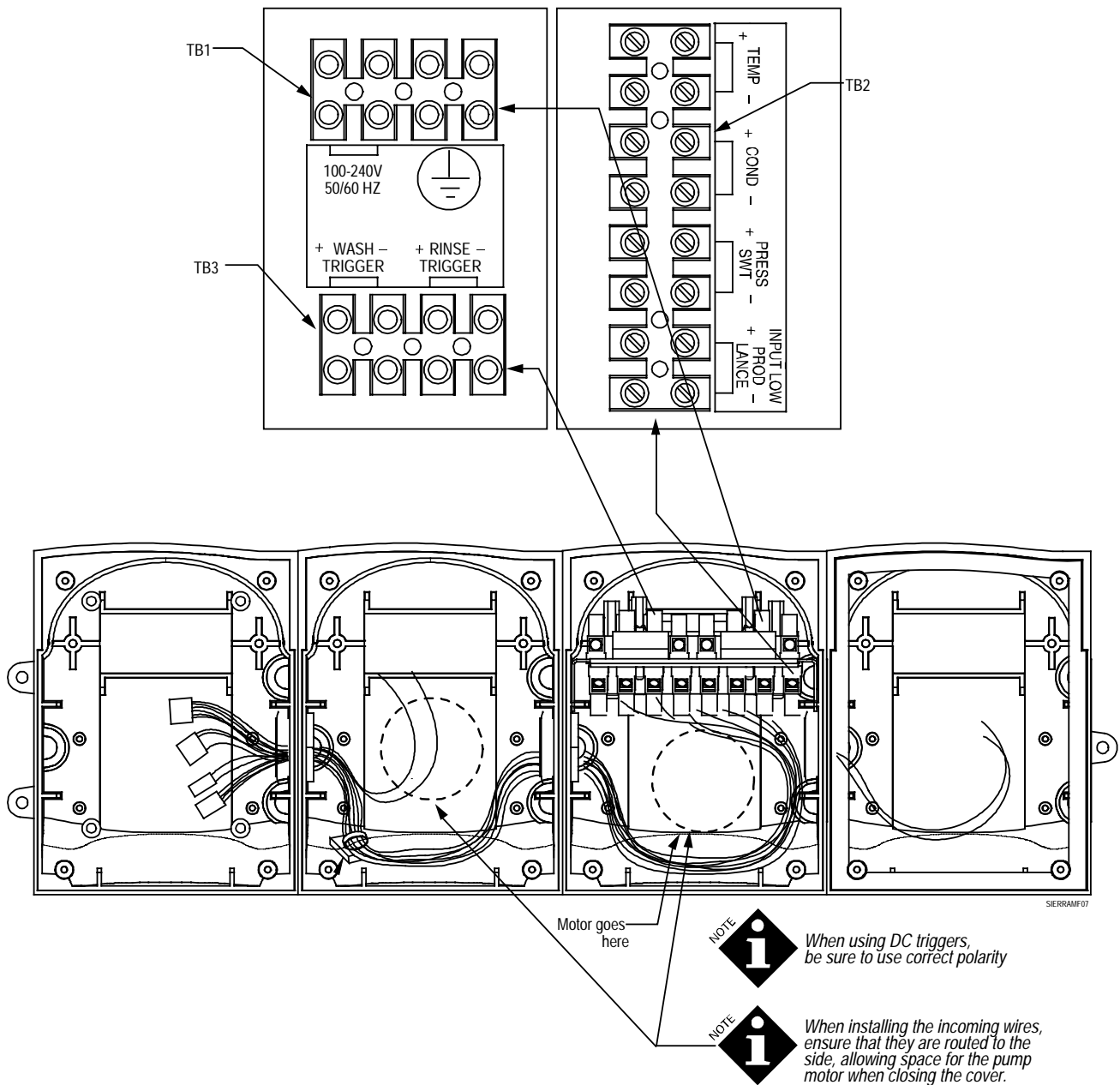

Figure 6. Sierra Wiring/Removable Terminal Blocks

Primary Power



Dangerous voltages may be present in the enclosure. Refer installation and service to qualified personnel only. Installation must comply with all applicable electrical codes.

Figure 6 shows inside of the Sierra, with enlarged images of each terminal block. The terminal block slides out for easy access to connections.

Locate electrical circuits on the dishmachine that provide power as described in Specifications. **Constant power must be supplied to the Sierra.** Connect the 2 legs of each power source to their appropriate terminals as detailed on the power wiring label.

The wash signal is connected across either the wash motor or the fill solenoid valve. The rinse signal is typically connected across the rinse solenoid valve. The wire enters through a conduit connector for safe installation.



When using DC triggers, be sure to use correct polarity.

Terminal Strip Connections

TB1 (shown in Figure 6) has connections for the input power and ground. TB2 (shown in Figure 6) has connections for temperature, conductivity, pressure switch and input for low-product alarm lance. TB3 (shown in Figure 6) has connections for the wash and rinse triggers.

Probe Connections

You may use a temperature compensated probe or a conductivity only probe with the Sierra. There are 4 connections for a compensated probe installation, and only 2 connectors when it is not compensated.

The probe wiring should be 22-gauge cable. During installation, the probe wires should be routed through a separate strain relief in the bottom of the unit. Running them together with power or trigger wires can distort the probe signal and is not recommended.

PROGRAMMING PROCEDURES

General

This section describes Sierra’s command buttons and the different programming/status screens used to configure your warewash system. For guidelines on configuring your Sierra to best suit your machine type and desired operating mode, please see **Applications** section.



Figure 7. Sierra Touch Pad and Screen

COMMAND KEYS

Key	Description and Function
	This is the UP/DOWN key pair. They are used to select screen options (such as “DOOR” for door machine or “CONVEYER” for conveyer machine) within a menu, to select different screens (such as the Run Screen), or to scroll through digits and select such numbers as setpoints and passcode numbers.
	This is the CURSOR key. It is used to move about the columns on a screen, such as the numbers on the PASSCODE screen (Screen 4), or the conductivity setpoint on Screen 9.
	This is the ENTER key. It is used to enter another screen level (submenu), start an action such as priming, or cancel an alarm.
	This is the SCROLL key. It is used to move from screen to screen within each Level. Pressing the SCROLL and ENTER keys simultaneously will take the user back to the Run Screen.

Table 3. Sierra Command Keys

SMART SCREENS

Sierra’s Smart screens are organized into four different levels (Levels 0 to 3) or “Loops.” Each Loop has its own set of programming options, described as follows.

Level 0: The Power Up Screen

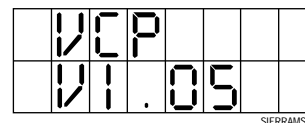

Screen 0: Power Up Screen

This is the first screen you will see when you power up the unit. This screen will stay on for approximately one second,

and will then proceed to **Level 1** automatically. The firmware version number appears on the second line of the screen as shown.

Level 1: The “RUN” Loop

Once Sierra has automatically proceeded to **Level 1**, the **Run Screen** (Screen 1) appears. The Run Screen is a default screen that the user programs to appear while the Sierra is running. The Sierra automatically defaults to **Screen 25** as the Run Screen, but the Run Screen can be programmed to be any of the **View Status** screens (**Screens 25-32**).

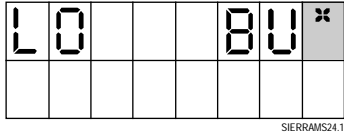

Run Screen: This screen (Screen 25) is the default Run Screen (Screen 1). Screens 25-32 may be set as the Run Screen.

From the Run Screen, press the SCROLL key to get to the Prime Pump Screen (Screen 2).

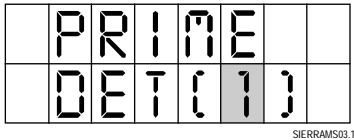

Screen 2. Prime Pump Screen

From Screen 2, press the UP/DOWN arrow key to cycle through and select desired pump (DET [1], RIN [2], or SAN [3]) for priming. Once you have cycled to desired pump, Press and hold the ENTER key to initiate the prime for that pump. Default setting is RIN [2].

When priming is complete, press the SCROLL key to move to Screen 3 for dosing status.

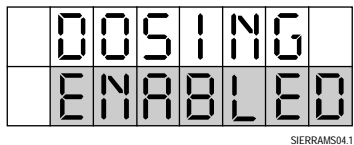

Screen 3. Dosing Screen, Enabled

In Screen 3, pressing the UP/DOWN keys will toggle the screen between DOSING ENABLED or DISABLED. By default, dosing is ENABLED.

When dosing is disabled, the screen will read as shown below, and “DOSING DISABLED” will flash continuously, once per second.

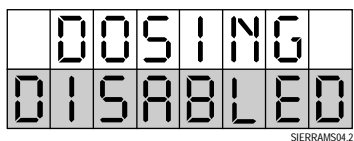

Screen 3. Dosing Screen, Disabled

From Screen 3, pressing SCROLL will take you to Screen 4, the Passcode Screen.

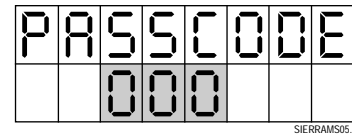

Screen 4. Passcode Screen

Entering the Default Passcode

When you first enter Screen 4, you will notice that the first of the three zeros is flashing. Since the default passcode is “000,” you may simply use the CURSOR key to navigate over the three digits, and when you are finished, press ENTER or SCROLL to advance to **Level 2**.

Entering Programmed Passcode

You may program your own 3-digit passcode (see Screen 24 under **Level 2: The Configuration Loop**). Once you have done this, you will need to enter it on Screen 4 anytime you want to advance to Levels 2 or 3. Use the UP/DOWN keys to select the correct numbers, and the CURSOR to advance between the three digits. Press ENTER or SCROLL to advance to Level 2.

If you enter an incorrect passcode, the following screen will appear:

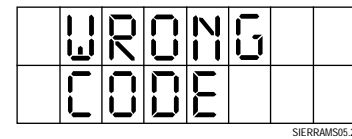

Screen 5. Wrong Code Screen. Activates if user enters incorrect passcode.

This screen will display for three seconds, and then revert back to the Passcode Screen (Screen 4). If you don’t want to advance to the next level, and just want to work within Level 1, you can press the SCROLL key, or wait 120 seconds. The unit will revert back to the Run Screen.

Level 2: The “Configuration” Loop

Best Practice for Easier Operation

Keep a record of your complete system setup (chemicals used, water heater BTU’s etc.). This will help reduce service time and maximize installation efficiency.

After entering the correct passcode from Screen 4, you will advance to Level 2, the Configuration Loop. The following screen appears:

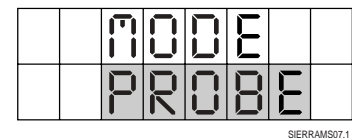

Screen 6. Mode Select Screen

Use the UP/DOWN keys to select PROBE or TIME mode (default is PROBE mode), and press the SCROLL key to advance to the next screen. Due to the Smart Screen feature, all subsequent configuration screens will apply only to the setting related to your selected control mode.

The next screen allows you to program your washer type. Use the UP/DOWN keys to select DOOR or CONVEYER

machine. Default is CONVEYER. Due to the Smart Screen feature, all subsequent screens will apply only to the machine type you've selected.

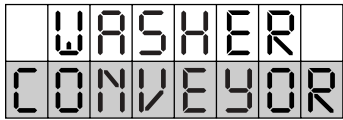

Screen 7. Washer Type Select Screen

Programming Conductivity Setpoint (Probe Mode Only)

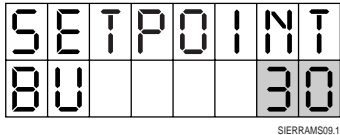

Screen 8. Conductivity Setpoint Screen

Selected digit will flash once per second. Using the UP/DOWN and CURSOR keys, enter desired conductivity setpoint within the range of 0 to 70 Beta Units. Default setpoint value is 30.

Programming Ratio Feed (Probe Mode Only)

The Sierra uses a Ratio Feed system (See “Probe Detergent Operation” section in the Introduction) to prevent the pump from overshooting the programmed conductivity setpoint.

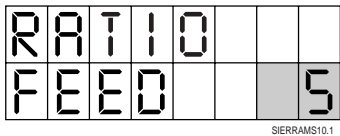

Screen 9. Ratio Feed Programming Screen

The Ratio Feed value in the lower right corner of the screen will flash once per second. Use the UP/DOWN keys to select a value from 0 to 9. Default value is 5.

Setting Detergent Alarm Timeout and Over Feed Stop (Probe Mode Only)

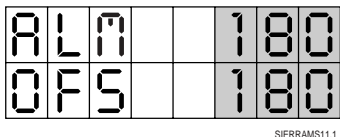

Screen 10. Detergent Alarm Timeout/Over Feed Stop Timeout Programming

Use the UP/DOWN and CURSOR keys to enter desired Detergent Alarm Timeout and Over Feed Stop Timeout. ALM stands for Detergent Alarm Timeout in seconds, and OFS stands for Over Feed Stop Timeout in seconds. Maximum programmable time for both elements is 240 seconds. Default time for both elements is 180 seconds.



When Detergent Alarm Timeout expires, screen will display the following:

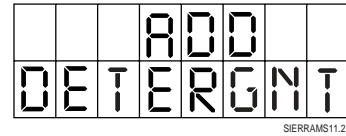

Screen 10a.

When Over Feed Stop Timeout expires, screen will display the following:

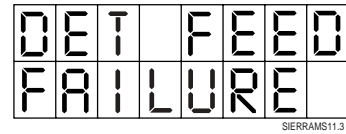

Screen 10b.

These screens will blink alternately with the following screen at 1-second intervals.



Screen 10c.

Press ENTER to cancel the alarm, and menu will return to the Run Screen.

If more than one error condition exists at a time, the error menu flashes alternately between the error conditions.

Setting Pump Speeds

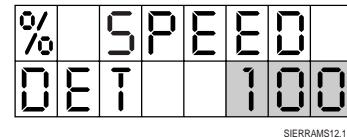

Screen 11. Pump Speeds

Use the UP/DOWN and keys to select each pump, and the CURSOR key to set their corresponding speeds from 5 to 100. The selected pump or digit will flash once per second. Holding down the ENTER key will run the corresponding pump at the programmed speed.

Default pump speeds are as follows:

- DET = 100
- RIN = 20
- SAN = 30

Detergent Initial Charge Trigger Time (Time Mode Only)

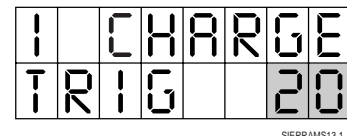

Screen 12. Initial Charge Trigger Time

Using the UP/DOWN and CURSOR keys, enter desired detergent initial charge trigger time between 5 and 99 seconds. Default time is 20 seconds.

Detergent Initial Charge Run Time (Time Mode Only)

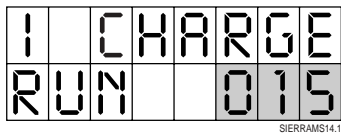

Screen 13. Initial Charge Run Time

Use the UP/DOWN and CURSOR keys to set desired detergent initial charge run time between 0 and 240 seconds. Default time is 15 seconds.

Detergent Recharge Run Time (Time Mode Only)

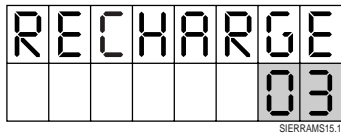

Screen 14. Detergent Recharge Run Time

Using the UP/DOWN and CURSOR keys, set desired detergent recharge time between 0 to 24 seconds. Default time is 3 seconds.

Rinse Delay Time (Door Machine Only)

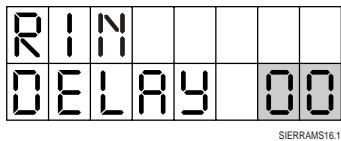

Screen 15. Rinse Delay Time

Using UP/DOWN and CURSOR keys, set rinse delay time between 0 and 20 seconds. Default time is 00 seconds.

Maximum Run Time for Rinse Pump (Door Machine Only)

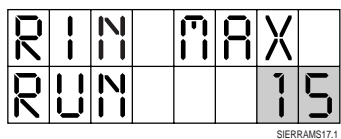

Screen 16. Maximum Run Time for Rinse Pump

Using UP/DOWN and CURSOR keys, set desired maximum rinse pump run time between 0 and 99 seconds. Default time is 15 seconds.

Setting Sanitizer Pump Trigger

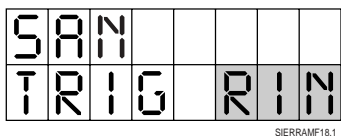

Screen 17. Sanitizer Pump Trigger Configuration

Screen 17 allows you to determine when the sanitizer pump will run. Use the UP/DOWN keys to toggle between “RIN” and “DET.” Selecting “DET” means the sanitizer pump will run when the detergent pump runs, and selecting “RIN” means the sanitizer

pump will run when the rinse pump runs, or during the rinse delay time. Default is “RIN.”

Setting Rack Transit Time (Conveyer Machines Only)

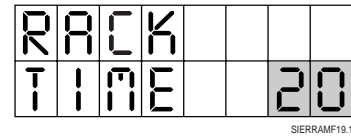

Screen 18. Rack Transit Time

Screen 18 lets you enter the time it will take a rack (or rack equivalent on flight machines) to move through a given point on a conveyer machine. Use the UP/DOWN and CURSOR keys to enter this time. Typically, this value is between 0 and 99 seconds. This value is for data logging counting racks on conveyer machines. Default time is 20 seconds.

Rack Transit for Door Machines

For door-type machines, a rack will automatically be counted if rinse trigger stays on for more than 3 seconds.

Setting Maximum Number of Racks to be Washed Between Drain Cycles

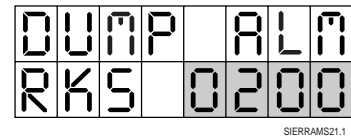

Screen 19. Wash Tank Dump Alarm

The Wash Tank Dump alarm is the maximum number of racks allowed between drains. Use the UP/DOWN keys to set desired value. Values are ---- (alarm is not active), 0010 to 9999. Default setting is 200. If the alarm is not required, set as “----” or the alarm will automatically activate at the default setting of 200 racks.



When the number of racks washed exceeds the number programmed in Screen 19, the display will show:

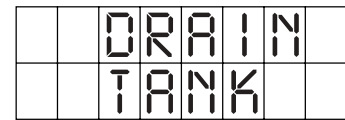

Screen 19a.

This screen will blink alternately with the following screen at 1-second intervals.



Screen 10c.

Press ENTER to cancel the alarm, and menu will return to the Run Screen.

If more than one error condition exists at a time, the error menu flashes alternately between the error conditions.

Language Selection



Screen 20. Language Selection

Use the UP/DOWN keys to select desired language, “ENGLISH”, “FRENCH”, “SPANISH”, or “NUMERIC”. Default is ENGLISH. Because the “Numeric” language is more difficult to understand than the text languages, we don’t recommend that you use it unless absolutely necessary.

Set/Change Passcode

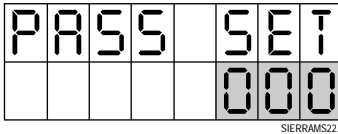

Screen 21. Setting/Changing Passcode

Using the UP/DOWN and CURSOR keys, enter a passcode between 000 and 998. Default passcode is “000.”



Do not set the passcode to 999. 999 will not work and you will be unable to access programming screens.

Advance to “Display Screens” Screen

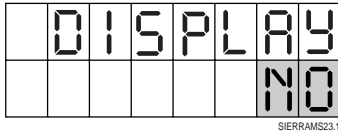

Screen 22. Advance to “Display Screens” Screen

Screen 22 gives you the option to either advance to the Level 3 screens, or to exit the Configuration Loop and go back to Level 1. If you want to advance to Level 3, use the UP/DOWN arrow keys to select “YES” and press the SCROLL key (default setting is “NO”).

If you want to leave Level 2 and go back to Level 1, select “NO”, and press the SCROLL key. The following screen appears:

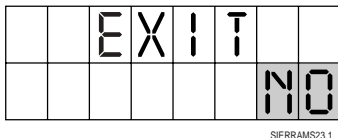

Screen 23. Exit Screen

Use the UP/DOWN keys to select “YES” if you’re certain you want to exit the Configuration Loop. Selecting “NO” will bring you back to the beginning of the Configuration Loop (Screen 6). Default setting is “NO.”

Level 3: The “View Status” Loop

Once you have selected “YES” from the Screen 22, you will then advance to Screen 24, the first Level 3 screen.

You may program any of the Level 3 screens to be the Run Screen. From any of the Level 3 screens, pressing the UP/DOWN keys will cause the asterisk (*) in the upper right corner to toggle on and off.

When the asterisk is visible, that screen is available for selection as a Run Screen. Default Run Screen is Screen 25.

You can view any of the Level 3 screens.

Conductivity Status

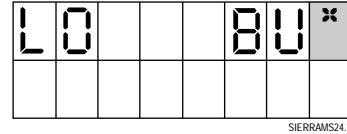

Screen 24. Wash Tank Conductivity

Screen 24 shows wash tank conductivity in Beta Units. Range is “LO” (open) 0 to 70, or “HI” (short).



When low product input is short, the display will show:



Screen 24a.

This screen will blink alternately with the following screen at 1-second intervals.



Screen 10c.

Press ENTER to cancel the alarm, and menu will return to the Run Screen.

If more than one error condition exists at a time, the error menu flashes alternately between the error conditions.

Conductivity/Temperature Status

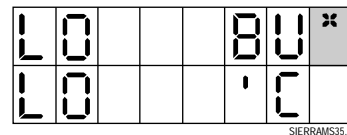

Screen 25. Conductivity/Temperature Status

Screen 25 shows wash tank conductivity in Beta Units and wash tank temperature in degrees Celsius. Range is “LO” (open), 0 to 99, and “HI” (short).

Diagnostic Screen

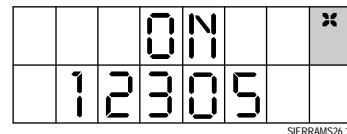

Screen 26. Diagnostic Screen

Screen 26 shows which triggers are on:

- “1” will display if wash trigger is on
- “2” will display if rinse trigger is on

“3” will display if rinse pressure switch input is on
 “5” will display if low product input is on

Rack Count

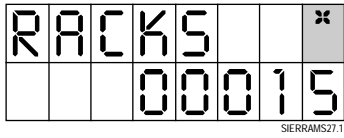

Screen 27. Rack Count

Screen 27 shows the total rack count. In the example shown, a total of 15 racks have run. This counter cannot be reset. It counts up to 99,999,999 and then rolls over to 0.



In time-door mode, the rack count also counts initial charge. When operating in time-door mode, subtract the total drain events from the rack total to eliminate the number of initial charges that have been added in.

Racks Since Drain Count

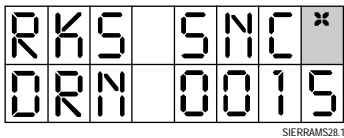

Screen 28. Rack/Drain Count

Screen 28 displays the number of racks washed since the last drain.

Total Detergent Pump Hours

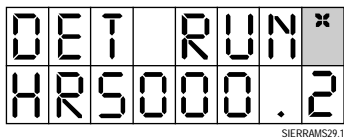

Screen 29. Total Pump “ON” Hours.

Screen 29 displays (in hours and tenths of hours) the total number of hours the detergent pump has run in its lifetime up to 999.9 hours. This time cannot be reset.

Total Drain Events

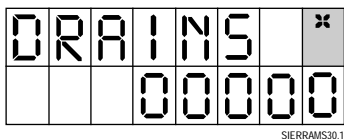

Screen 30. Total Drain Events

Screen 30 displays the total number of drain events that have occurred in the Sierra’s lifetime. In the example shown, there have not been any drain events yet. It counts up to 99,999,999 and then rolls over to 0. This counter cannot be reset.

Total Wash Trigger ON Hours

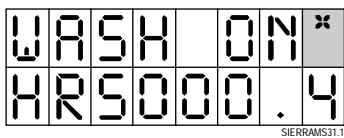

Screen 31. Total Wash Trigger ON Hours

Screen 31 displays the total number of hours the wash trigger has been on in its lifetime. This time is expressed in hours and tenths of hours up to 999.9 hours. Counter cannot be reset.

Exit Screen

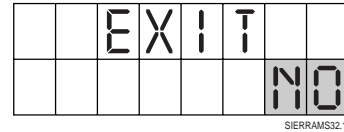

Screen 32. Exit Screen

Screen 32 gives you the option to either exit back to Screen 6 (first screen of Level 2), or back to Level 1. A “NO” response will bring you back to Level 2, and a “YES” response will bring you back to Level 1. Use the UP/DOWN keys to select, and SCROLL key to execute “YES” or “NO”. Default is “NO”.

Alarm

Probe Mode Display

While operating in probe run mode, the display shows actual tank concentration in Beta Units or temperature in degrees C. Note that the first tank concentration display character may be a hyphen (-) or blank. It is not a minus sign. To toggle between displaying tank concentration and temperature, briefly press the program/run button.

If necessary, use the following chart to convert Celsius to Fahrenheit.

°C	°F
0	32
10	50
20	68
25	77
30	86
35	95
40	104
45	113
50	122
55	131
60	140
65	149
70	158
80	176
90	194
100	212

MAINTENANCE

PERIODIC MAINTENANCE



TURN OFF all power before servicing.

Servicing Interior Components

To access interior, slide top cover up and gently pry off. It may be necessary to pry the cover off with a flat-head screwdriver. If this is necessary, take care not to damage the unit. Then remove the four screws.

Pump & Squeeze Tube Replacement Schedule

Since every installation is different (chemicals, tube runs, operating frequency, etc), an exact tube replacement schedule cannot be specified. With use, the tube slowly evolves from round to oval and the amount of chemical pumped decreases. By regularly checking the amount of chemical pumped, you can determine general tube life. We recommend that you closely monitor the time it takes the original tube to reach the end of its flex life, and then establish a replacement schedule. Replacing tubes at regularly scheduled intervals ensures more accurate product use and reduces service calls. In general, using short feed lines of a large diameter will improve pump tube life.



It is very important not to let the tubes become worn to the point where they tear and allow chemicals to saturate the pump housing.

How to Replace Pump Cartridges and Squeeze Tubes

Only the cartridge replacement should be done in the field. Tube replacement can be accomplished later. Note that each product has different delivery line configurations and squeeze tubes. Refer to the **Table 2** in the **Installation and Setup** section under **Connecting Chemical Supply Lines** for the available tubing sizes. Refer to the **Specifications** for tubing materials.

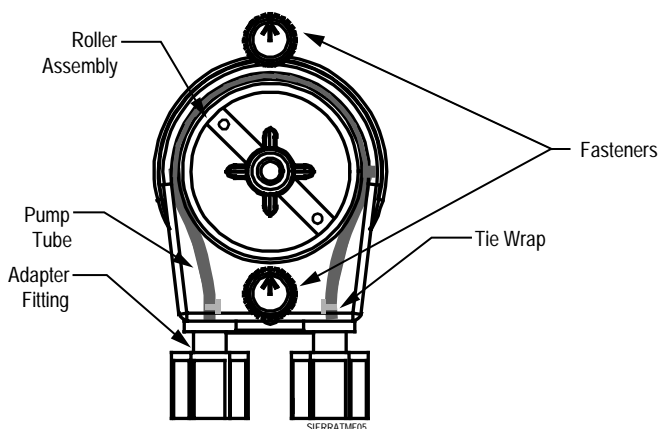

Figure 8. SnapHead Pump

To Remove

1. Disable unit, or turn off main power.
2. Remove the cartridge from the motor housing by twisting the two quarter turn fasteners at top and bottom counterclockwise while gently pressing.



Wear adequate protective clothing such as gloves and safety goggles.

3. Remove the supply and feed lines from the old pump squeeze tubing and connect them to the new pump squeeze tubing.

To Install

1. Disable unit, or turn off main power.
2. Align and engage the pump drive spline with the motor gear.
3. Turn the fasteners so that arrows are pointing upward.
4. Hold the cartridge vertically and press the fasteners into the motor housing until you hear a distinct click.



It is very important that the tabs are vertical and that you press them firmly enough to hear them click. Incorrect installation could damage the pump.

How to Change the Pump Squeeze Tubing

1. Remove the cartridge as described above.
2. Remove the small screw at the bottom of the rear cover and lift the cover from the cartridge.
3. Pull the adapter fittings rearward until they clear the cartridge.
4. Pull the roller assembly rearward to release the pump squeeze tubing.
5. Cut the tie wraps holding the pump squeeze tubing to the adapter fitting and pull the tubing from the fittings.
6. Replace the pump squeeze tubing making certain to use the proper size tube.
7. Push the adapters on to the ends of the tubing and secure with tie wraps. Make certain that the "buckles" of the tie wraps are both facing the same direction. This will keep the tube from twisting in the cartridge.
8. When using B-Flex tubing, coat the inside of the cartridge with a liberal amount of Silicone 111 lubricant.
9. Press the 2 adapter fittings into the cartridge so that the tie wrap "buckles" face toward the center of the pump.
10. Push the roller assembly onto the cartridge shaft using a twisting motion to engage the rollers properly with the pump squeeze tubing.
11. Return the rear cover and secure with the small screw at the bottom. The flat side of the cover should face inward.

How To Replace Pump Motor and Solenoid Subassemblies

To Remove

1. Ensure power and all triggers are off/disabled.
2. Remove the pump cartridge from the motor assembly, leaving the chemical lines attached.
3. Remove the electrical connections at the back of the motor.
4. Compress the two flex ears on the back of the motor until the motor slides out through the hole in the cabinet.

- For detailed information on Sierra subassembly structure, please see **Appendix B**.

To Replace

- Ensure power and all triggers are off/disabled.
- Locate the alignment tip of the pump motor housing so it is in the down position.
- Slide the pump motor housing into the enclosure hole. The holding ears will expand to hold the pump motor/solenoid in place. Verify that both ears popped out and are locked in place.
- Reinstall the electrical connections at the back of the motor (Refer to **Appendix B** for wiring diagram).
- Install the pump cartridge.
- Prime the pump to verify proper pump rotation (clockwise). If the direction is wrong, switch the motor wires.

Cleaning The Probe

You must clean the conductivity probe tips (electrodes) on a regular basis to ensure control accuracy. The water conditions (*for example*, water hardness) and the type of soil load are the primary factors in determining a cleaning schedule.

To clean, use a plastic scrubbing pad or acid descaler. **Do not use wire wool.**

TROUBLESHOOTING

Refer to the assembly drawings and the complete unit wiring diagram in the **Appendix B**. To order replacement spares, see **Accessories and Spare Parts**. Please order using the item number.

No Power



The following procedure is to be performed only by qualified personnel.

Check the following:

- Check power supply terminal strip connection (TB1-1,2) and verify that there is appropriate line voltage.
 - If there isn't appropriate line voltage, check wiring and power supply.
 - If there is appropriate line voltage, proceed to Step 2.
- Confirm connection CN1 is firmly seated on the power supply board. If firmly connected and the Sierra is still not functioning remove CN1 and confirm that appropriate line voltage (100-240VAC) is present on the input wire.

If there isn't appropriate line voltage is present, check wiring between CN1 and TB1. If there is appropriate line voltage, proceed to Step 3.
- Reconnect CN1. Disconnect J2. Confirm that appropriate input voltage (24VDC) is present.
 - If there isn't appropriate line voltage, replace Sierra power supply PCB.
 - If there is appropriate line voltage, replace Sierra controller PCB.

Chemical Feeds Too Often/Too Much Chemical Used

Check the chemical control setup and harness. (Refer to the original setup records.) If wrong, correct. If OK, replace the PCB.

Chemical Does Not Feed at All (Pump Doesn't Turn)

- Ensure dosing is enabled.
- Check the chemical control setup, including setup menus and input triggers. (Refer to the original setup records.) If wrong, correct.
- Use voltmeter to verify 24 VDC is present on pump driver wires while priming. If 24 VDC is present, replace pump motor. If 24 VDC is not present, disconnect harness and test at PCB output. If 24 VDC is not present at PCB output, replace PCB; if present, replace harness.

Chemical Pump Feeds Continuously

Check the preset run time of the pump and the operation of the prime button. If the pump continues to run beyond that run time, check the wiring harness. If pump still feeds continuously, replace the Sierra Main PCB.

Pump Will Not Pull the Chemical Out of the Drum

- Too much vacuum created. The supply line in the chemical drum may be up against either the side or bottom, the supply lines may be too long for a viscous product, or there may be a crimp in the intake supply line, thus exceeding the pump's vacuum specifications.
- There may be an air leak somewhere in the input supply line. Most often this is caused by inadequate sealing of the supply line into the line nuts. See **Installation and Setup** section for recommended procedure.
- Squeeze tube is worn and the rollers can no longer squeeze the tube properly. Correct by changing the pump cartridge with the correct size squeeze tube and line nuts for the chemical being pumped.

Unit Only Displays Numbers and Not Language

- If you determine the Sierra is in Numeric mode, reprogram to desired language.
 - Press the SCROLL key until the top line shows "1.3" and the bottom line shows "000".
 - Change the "000" to the passcode and press the ENTER key until "2.16 is displayed on the top line and "NUMERIC" is displayed on the bottom.
 - Press "+" to change the language to English, French or Spanish, and the ENTER button to continue to other menus.
- If the unit still does not display language, call Technical Services for further troubleshooting.

ACCESSORIES & SPARE PARTS

The items listed in this section provide you with quick reference numbers for some of the major parts and accessories. A complete exploded assembly drawing is located in the back of the manual.

Spare Parts and Accessories

Strain Relief	032121
Mounting Bracket	069188
Power Supply PCB 100-240 VAC	087751
Main PCB	069489
Wall Mounted Solenoid Valve Kit	035701
1/2" Watertight Plastic Conduit Elbow	068529
Low-Level Alarm Lance	1201180
1/2" Plug	041236
7/8" Plug	041235
3/4" Strain Relief, 0.23" – 0.55" Nylon	090369
Chemical Tubing Standpipe	036857
Poly Single-Wall Bulkhead Fitting, 70°, 5/8" ID Tube, Barb	035542
Poly Double-Wall Bulkhead Fitting, 70°, 23mm OD Tube	051177
Poly Single-Wall Bulkhead Fitting, 90°, 1/4" PD Tube	022031
Miscellaneous Pump Spares	
Pump Roller Assembly	039550
Quarter Turn Pin for Pump (10 pack)	050670
Pump Motor Gearbox	051351

Accessory Kits

Sierra Sanitizer Pump Accessory Kit	1201231
Probe Kit (Conductivity Only) Model CP3400 Stainless Steel, K=0.4	018079
Probe Kit (Temperature Compensated) Model CP3403 Stainless Steel, K=0.4	099925
Probe Kit (Conductivity) with Bulkhead Fitting Model CP3300 D42, Polypropylene (body), 304 Stainless Steel, K=0.4	035395
Probe Kit (Temperature Compensated) with Bulkhead Fitting, Model D44, Polypropylene, (thermistor) K=0.4	035380



Pump tubes are also available in Norprene, Nordel, Silicone, C-Flex, and Viton.

TECHNICAL ASSISTANCE

If you require additional technical information, contact our Technical Support Department at 1-800-215-6415. From Europe, please call 0800-052-4726.

RETURNING EQUIPMENT FOR REPAIR

If you need to send an item back to be repaired, you must call or write to obtain a Returned Authorization (R.A.) Number before sending it back. Please write the R.A. number on the outside of the box before sending it back. It is also very helpful to our repair department if you include a note inside the box explaining the nature of the problem. Failure to obtain an Return Authorization Number before sending an item in for repair or replacement may delay the return of your equipment, and a \$25 handling fee will be incurred.

APPENDIX B: ASSEMBLY DRAWINGS

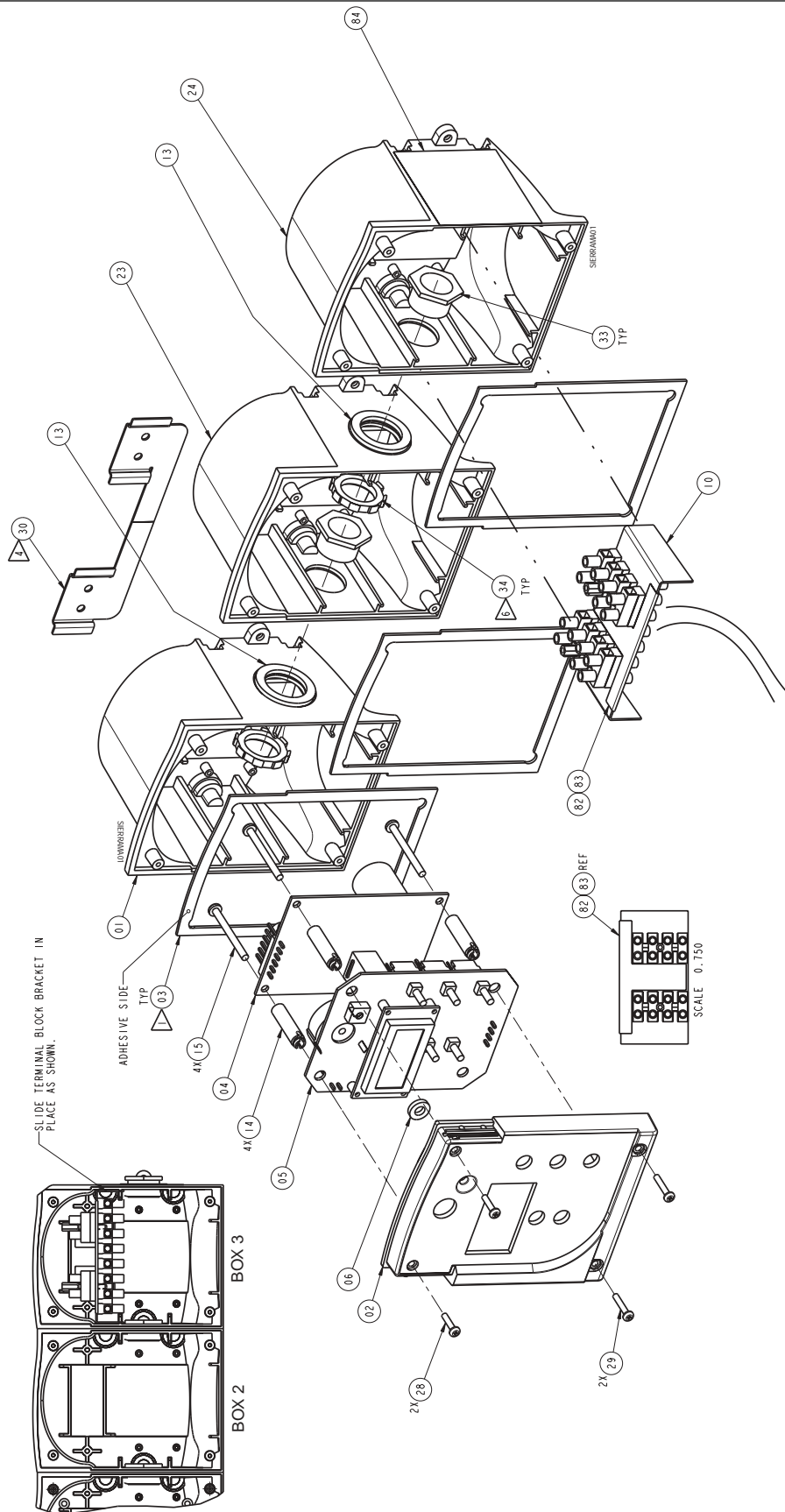

Seq.#	Item#	Description
01	1200453	ENCL,BUCKET,GRY
02	1203255	ENCL,BEZEL,CONT,SIERRA,GRY
03	069630	GSKT,ENCL
04	087751	PCB ASSY,PWR SPLY,90-264VAC
05	069097	PCB ASSY,SIERRA MAIN W/VCP
06	087415	GSKT,LED,NPRN,PSA
10	069653	HARN,PWR/IO,TERM BLK,SIERRA
13	069180	WSHR,FL,1.25ODX.88IDX.13,NPR
14	069135	SPCR,SNP,9/32RND,#6X1,NYL
15	068516	SCR,T-B,PH PNH,#6X1, ZP STL

Seq.#	Item#	Description
23	1203301	ENCL BUCKET, GREY
28	099688	SCR,T-B,PH PNH,#4X1/2,SST
29	099689	SCR,T-B,PH PNH,#4X5/8,SST,BLK
30	069188	BRKT,MTG,SIERRA
33	069665	CFTG,NIP,CHASE,1/2",STL
34	041077	NUT,LK,1/2,CND
35	038153	LBL,HZR,WARN,CSA
50	068648	CAP,MOT

APPENDIX B: ASSEMBLY DRAWINGS

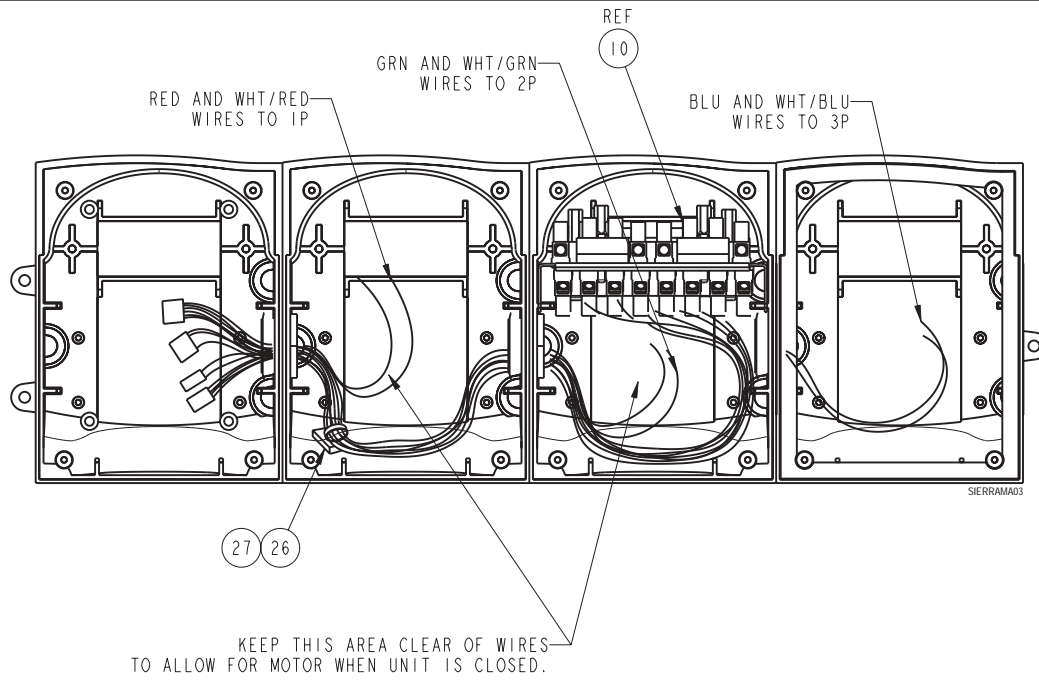

WIRE ROUTING

Sequence Number references on Page 21

APPENDIX B: ASSEMBLY DRAWINGS

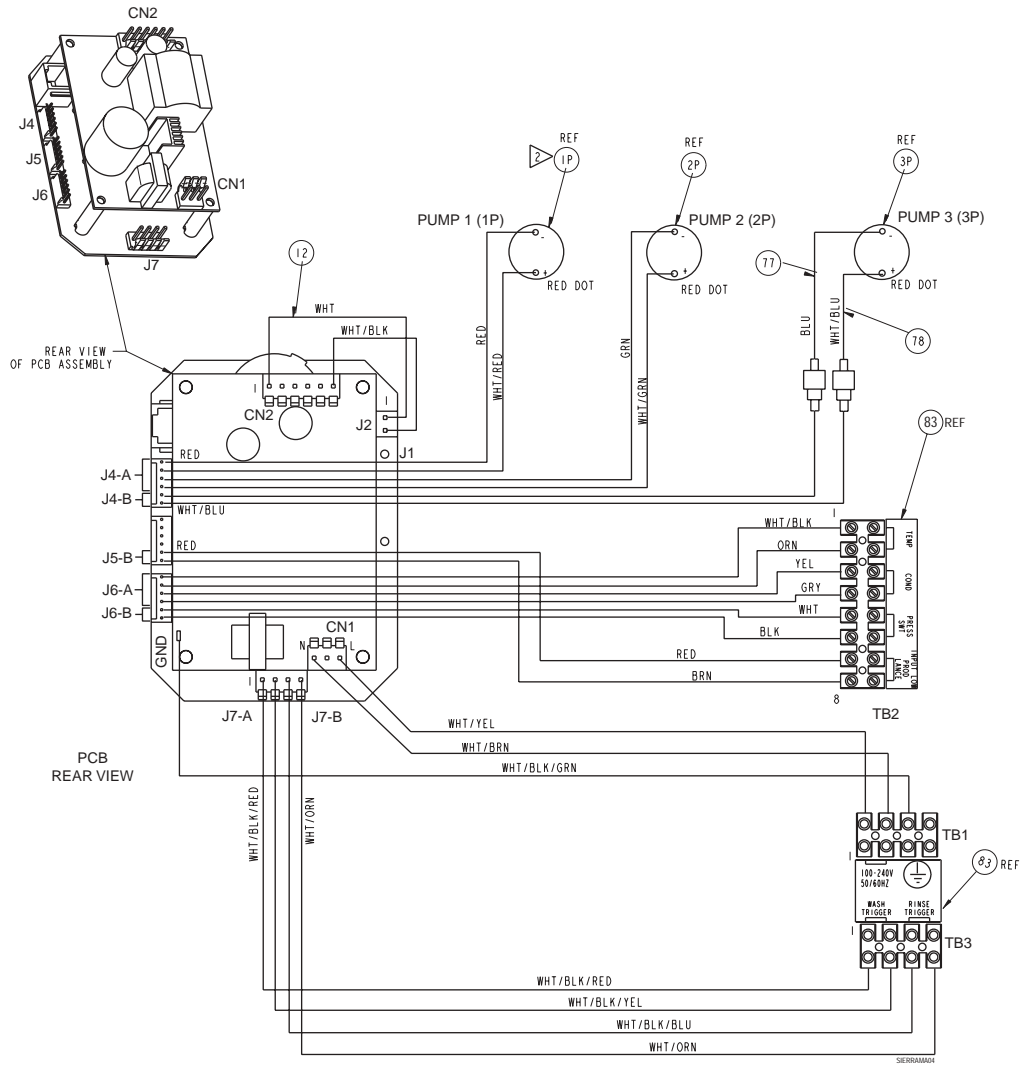

Sequence Number references on Page 21

Seq.#	Item#	Description
52	1203269	ENCL,DOOR,ABS
55	099705	GSKT,PMP
69	1203303	ENCL,BUCKET,D250,LFT KO
74	1203261	ENCL.BEZEL,PMP MDL,SIERRA,GRY
77	1200409	WIRE S/A,BLU,10",22GA,RQ/Q
78	1200410	WIRE,S/A,WHT/BLU,10",22GA, RQ/Q
1P		Contact Customer Service
2P		Contact Customer Service
3P		Contact Customer Service



Beta Technology, Inc

2811 Mission Street
 Santa Cruz - CA
 U.S.A. - 95060

TEL • 831 • 426 • 0882
 TEL • 800 • 858 • 2382
 FAX • 831 • 423 • 4573
 FAX • 800 • 221 • 8416

Customer Service

TEL (U.S. and Canada) • 800 • 468 • 4893
 TEL (outside U.S. and Canada) • 410 • 228 • 1292

Tech Support

sales@beta-technology.com

Beta Technology, Inc

4 Finway, Dallow Road
 Luton LU1 1TR
 United Kingdom

Freephone • 0800 • 052 • 4726
 Tel • +44(0) • 1582 • 528600

Customer Service

Fax • +44(0) • 1582 • 528111

Freephone • 0800 • 052 • 4726
 VAT REG.NO.BG.354 - 09975 - 44

europa.sites@beta-technology.com

Online Ordering: <http://www.beta-technology.com>

*VCP is a trademark of Beta Technology.
 Beta Technology is ISO9001 Certified.